

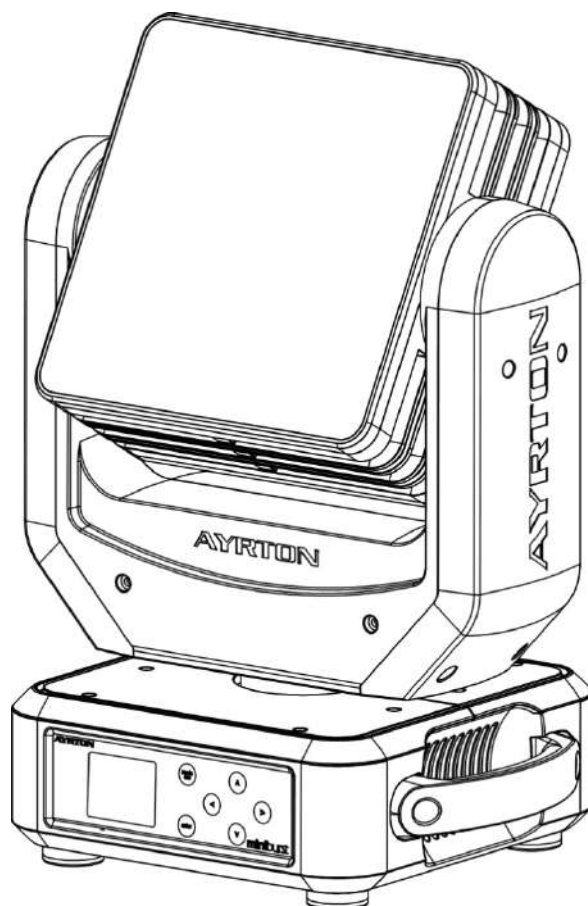

Manuel d'utilisation



miniburst

KEEP THIS MANUAL FOR FUTURE NEEDS



CONTENTS

1. SAFETY INSTRUCTIONS	2
2. FEATURES	3
3. FIXTURE OVERVIEW	6
4. DIMENSIONAL DRAWINGS	7
5. INSTALLATION INSTRUCTIONS	8
6. DMX-512 CONTROL CONNECTION	11
7. DMX-512 CONNECTION WITH DMX TERMINATOR	11
8. DEVICE DMX START ADDRESS SELECTION	12
9. OPERATING INSTRUCTIONS OF THE INTERNAL DMX WIRELESS SYSTEM	12
10. DISPLAY	13
11. DMX PROTOCOL	26
12. ERROR MESSAGES	30
13. CLEANING AND MAINTENANCE	30

1. SAFETY INSTRUCTIONS

1.1. IMPORTANT SAFETY WARNING

This device has left the factory in perfect condition. In order to maintain this condition and to ensure safe operation, it is absolutely necessary for the user to follow the safety instructions and warning notes written in this user manual.

In order to install, operate, and maintain the lighting fixture safely and correctly we suggest that the installation and operation be carried out by qualified technicians and these instructions be carefully followed.

	CAUTION! HIGH VOLTAGE. RISK OF SEVERE OR FATAL ELECTRIC SHOCK
---	---

	CAUTION! ALWAYS DISCONNECT MAINS SUPPLY BEFORE REMOVING ANY FIXTURE COVERS
---	--

	CAUTION! NEVER LOOK DIRECTLY INTO THE LIGHT SOURCE. SENSITIVE PERSONS MAY SUFFER AN EPILEPTIC SHOCK
--	---

	CAUTION! NEVER TOUCH THE DEVICE DURING OPERATION! COVERS MAY BE HOT
---	---

 **Important:**
Damage caused by the disregard of this user manual is not subject to warranty. The dealer and manufacturer will not accept liability for any resulting defects or problems.

- If the device has been exposed to temperature changes due to environmental conditions, do not power on immediately. The resulting condensation could damage the device. Leave the device powered off until it has reached room temperature.
- Ensure the sealing rubber covers of power CON and XLR connectors are fitted properly when the device is not in use, to avoid water ingress.
- This device falls under protection-class I. Therefore, it is essential that the device be earthed.
- If either lenses or display are damaged (damage may include cracks or gashes in the material) they must be replaced.
- Electrical connections, such as replacing the power plug, must be performed by a qualified person.
- Make sure that the available voltage is not higher than that which is stated at the end of this manual.
- Make sure the power cord is never crushed or damaged by sharp edges. If this should be the case, replacement of the cable must be done by an authorized dealer.
- If the external flexible power cord of this device is damaged, it shall be exclusively replaced by the manufacturer or their service agent or a similar qualified person in order

to avoid injury.

- When the device is not in use or before performing maintenance, always disconnect the device from the mains. Only handle the power cord from the plug. Never pull the plug out of a socket by tugging the power cord.
- When powered on for the first time, some smoke or smell may occur. This is caused by coating on metal parts when heated and is normal. If you are concerned, please contact your distributor.
- Do not focus the beam onto flammable surfaces. The minimum distance between the exiting lens of the device and the illuminated surface must be greater than 0.5 meter.

Please be aware that damage caused by any modifications to the device are not subject to warranty. Keep away from children and non-professionals.

1.2. GENERAL GUIDELINES

- This device is a lighting effect for professional use on stages, in discotheques, theatres, etc. the device was designed for indoor use.
- This fixture is only allowed to be operated within the maximum alternating current as stated in the technical specifications in section 2 of this manual.
- Handle the device with care, avoid shaking or using force when installing or maintaining the device.
- If you use the quick lock cam when rigging the device, make sure the quick lock fasteners are located in the quick lock holes correctly and securely.
- Operate the device only after having familiarized yourself with its functions. Do not permit operation by persons not qualified for operating the device. Most damage is the result of unprofessional operation.
- Please use the original packaging if the device is to be transported.
- The applicable temperature for the device is between -10°C to 45°C. Do not use the device outside of this temperature range.
- The light source of this luminaire is not replaceable; when the light source reaches its end of life the whole luminaire shall be replaced.

For safety reasons, please be aware that all modifications to the device are forbidden.

If this device is operated in any way different to the ones described in this manual, the product may suffer damage and the warranty becomes void. Furthermore, any other operation may lead to short-circuits, burns, electric shocks etc.

2. FEATURES

POWER SUPPLY

- AC100-240V~, 50/60Hz
- Power Consumption: 340W

LIGHT SOURCE

- LED: 960 pcs OSRAM white LEDs
- Extremely long Life: >50,000H

MOVEMENT

- Pan movement: 540° /630° Optional (16 bit)
- Tilt movement: 270° /540° (16 bit)
- Advanced moving system: fast, stable and quite, auto x-y repositioning

FEATURES

- 4 Control channel modes: 14/12/59/29 channels
- 2 Operation modes: DMX-512, Master / Slave mode
- Strobe effect with 1-25 flashes per second and pulse effect
- Dimmer: 0%~100% full range dimming

DISPLAY

- Advanced and convenient full-color LCD, with rechargeable battery(optional)
- Can be changed 180° reverse to fit for different installation position

SOFTWARE

8 pre-installed programs available upon selection

Upgrades: fast and convenient through DMX cable with DMX-512 controller

Reset DMX address, remote lamp control, reset can all be done by the DMX controller

Running time of fixture on display for reference

OTHER SPEC

Advanced RDM function

WEIGHT

Net weight: 8.5 kg

DMX CHANNEL CHART

	1	2	3	4	5	6	7	8	9	10	11	12	13	14
%	Pan	Pan Fine	Tilt	Tilt Fine	Speed Pan Tilt movement	Pan Motor continuous rotation	Tilt Motor continuous rotation	Dimmer intensity	Duration	Rate	Chase Patterns	Chase Speed	Chase Fade	Auto programs
100%		16bit Pan Fine 		16bit Tilt Fine 	No function	Backwards Pan rotation from slow to fast	Backwards Tilt rotation from slow to fast				Reserved	Slow to Fast Forward		Program 8 ⋮ Program 1
75%					Blackout by movement						Chase 57 ⋮ Chase 30		Fade Chase	no function
50%					Min ↑ Moving speed ↑ Max	No rotation	No rotation		duration from 2msec to 600msec	from 1 flash evry 4 sec to 25 flash evry secretary	Chase 1 Led trun off	Stop (Speed=0)		no function
25%						Forwards Pan rotation from fast to slow	Forwards Tilt rotation from fast to slow			led off		Fast to Slow Backward		no function
0%						no function	no function							Scan motor reset All motor reset Normal

3. FIXTURE OVERVIEW

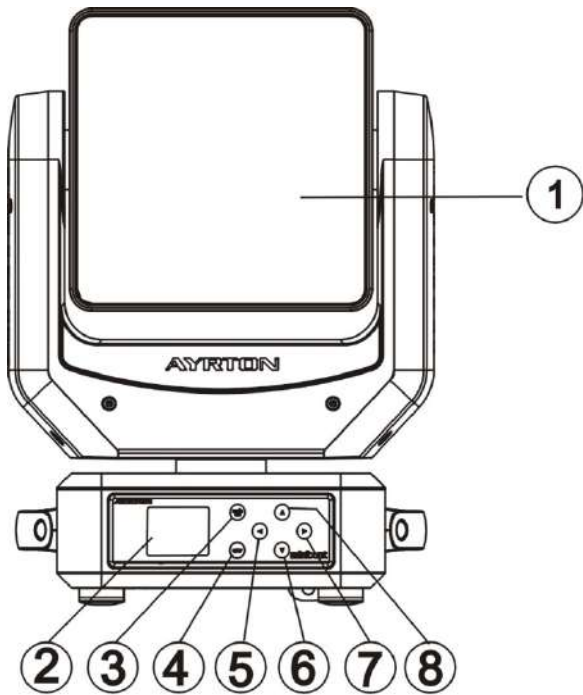

- 1) LED Assembly
- 2) Display
- 3) Mode/Esc-button
- 4) ENTER-button
- 5) Left-button
- 6) Down-button
- 7) Right-button
- 8) Up-button

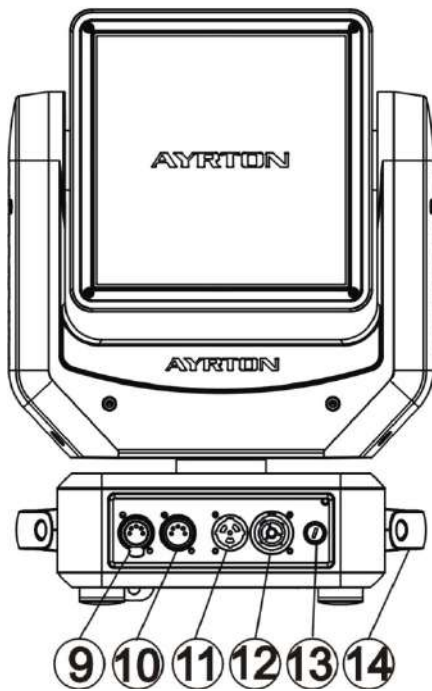

- 9) DMX Out
- 10) DMX In
- 11) Power In
- 12) Power Out
- 13) Fuse
- 14) Handle

4. DIMENSIONAL DRAWINGS

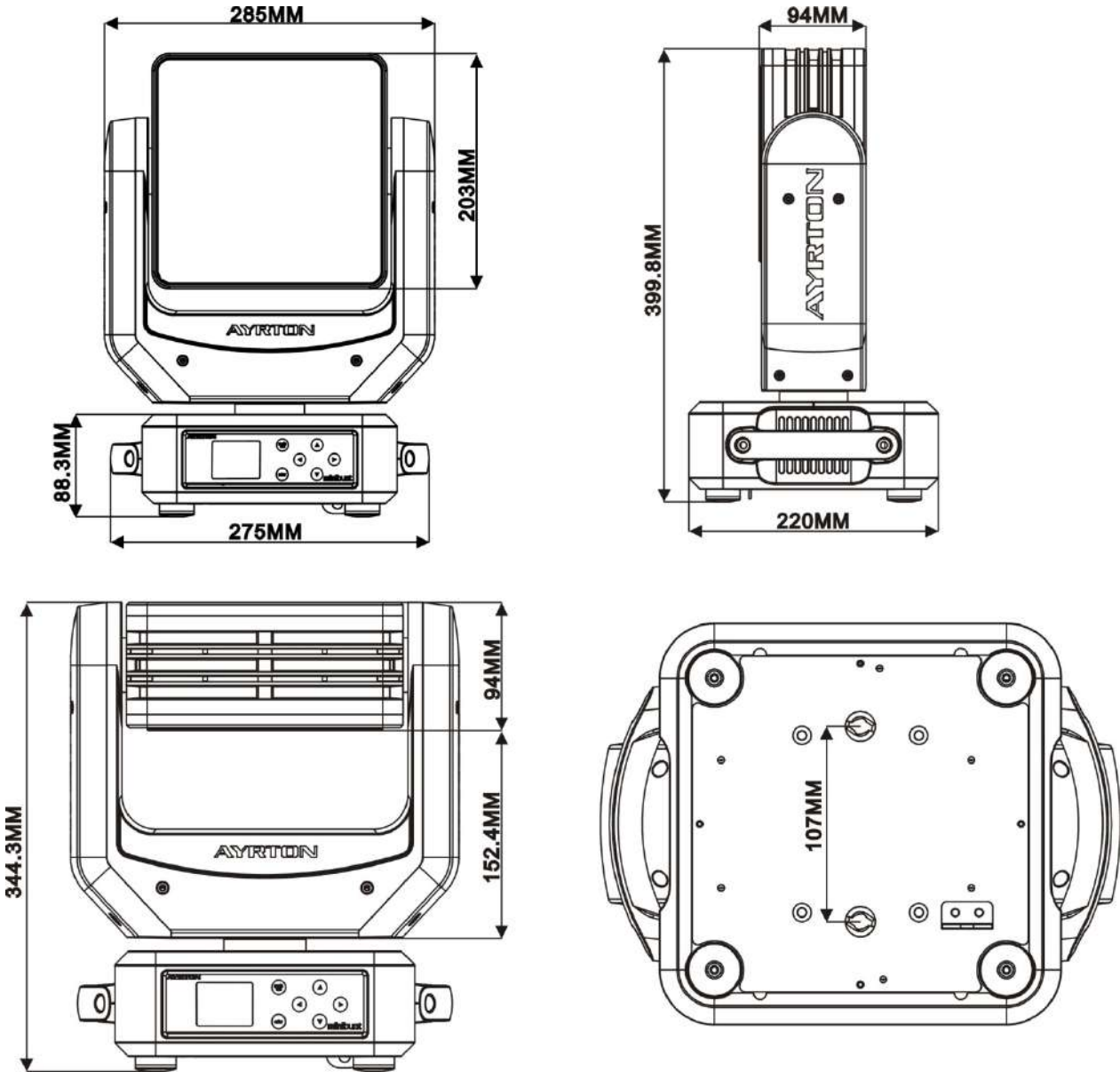

5. INSTALLATION INSTRUCTIONS

5.1. Rigging the device



CAUTION!

PLEASE CONSIDER THE RESPECTIVE NATIONAL NORMS DURING INSTALLATION. THE INSTALLATION MUST ONLY BE CARRIED OUT BY A QUALIFIED PERSON.

- The applicable temperature for the lighting is between -10°C to 45°C . Do not use the lighting under or above the temperature.
- The installation of the effect has to be built and constructed in a way that it can hold 10 times the weight for 1 hour without any harming deformation.
- The installation must always be secured with a secondary safety attachment, e.g. an appropriate safety rope.
- Never stand directly below the device when mounting, removing or servicing the fixture.
- The operator has to make sure the safety relating and machine technical installations are approved by an expert before taking the device into operation for the first time.
- These installations have to be approved by a skilled person once a year.
- Overhead mounting requires extensive experience, including amongst others calculating working load limits, installation material being used, and periodic safety inspection of all installation material and the device. If you lack these qualifications, do not attempt the installation yourself. Improper installation can result in bodily injury.

5.2. Rigging using the omega brackets

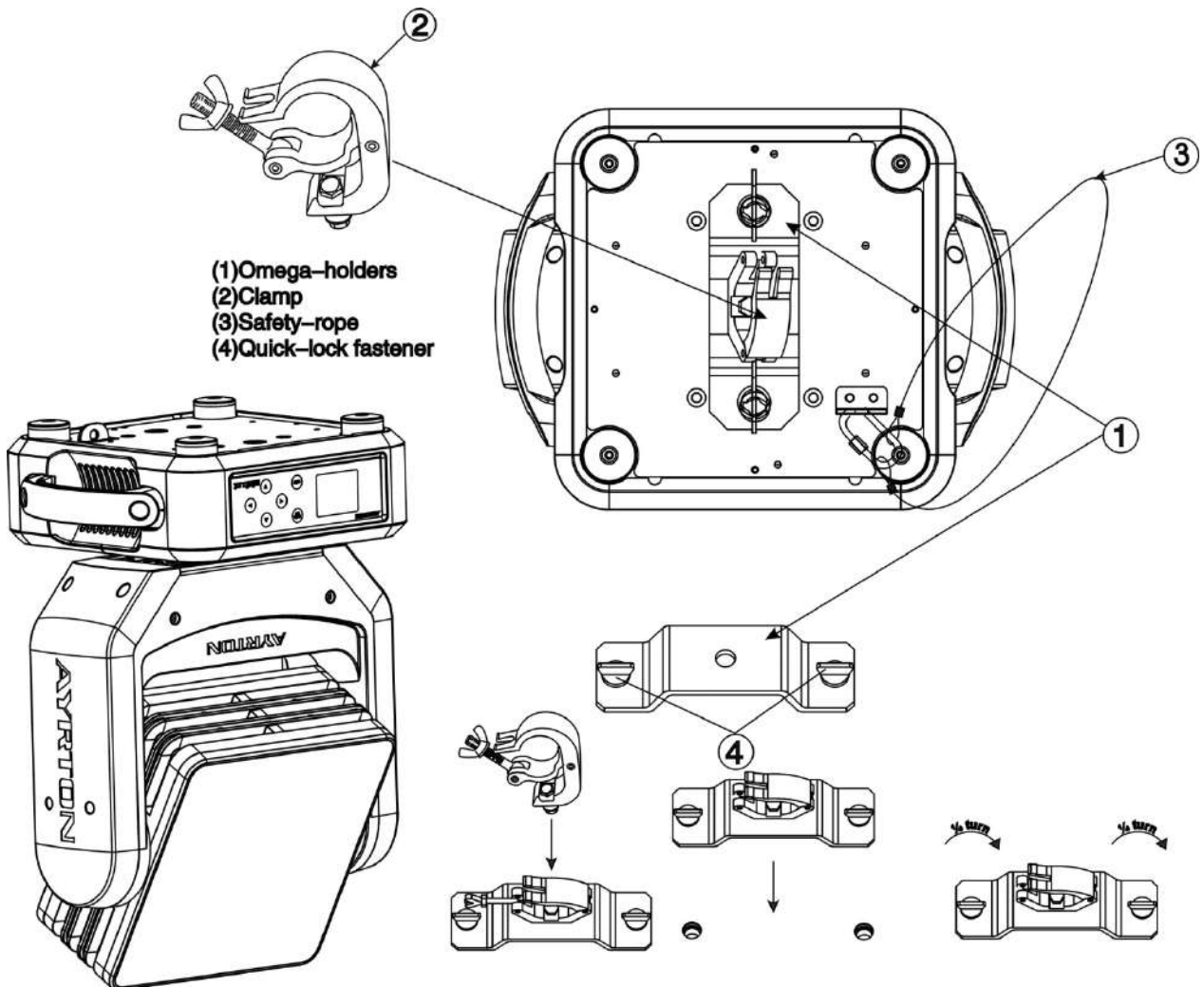

- Fix the clamp to the bracket by tightening the M12 nut and bolt to the bracket through the $\Phi 13$ hole in the middle of the bracket.
- Insert the quick-lock fasteners of the first Omega holder into the respective holes on the bottom of the device. Tighten the quick-lock fasteners fully clockwise.
- Install the second Omega holder.
- Pull the safety cable through the holes on the bottom of the base and over the trussing system or another suitable rigging point. Insert the end into the carabiner and tighten the safety screw.



Important:

This step is very important to ensure safe rigging of the fixture.

5.3. RIGGING DRAWINGS

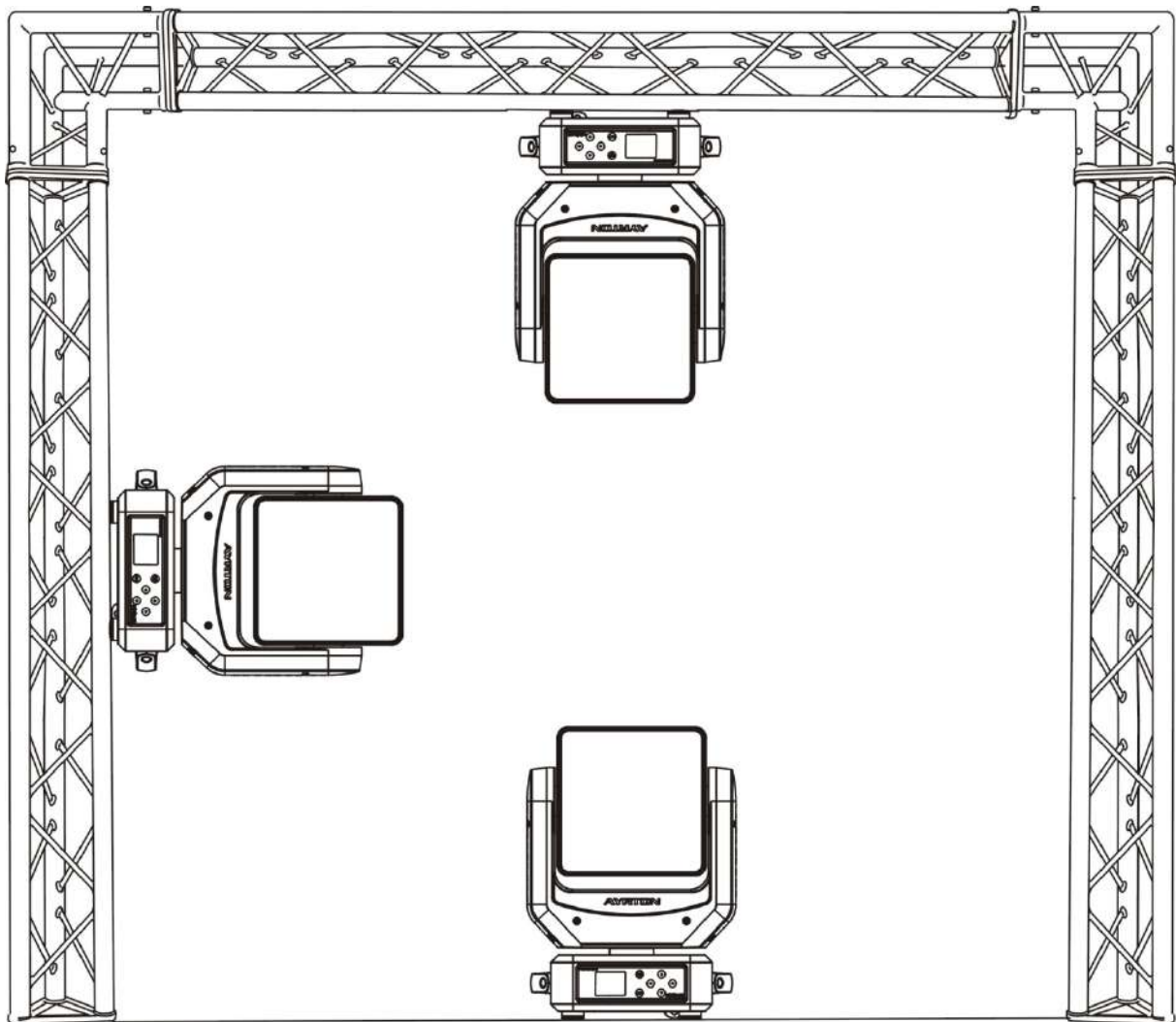

- Be sure this fixture is kept at least 0.1 m away from any flammable materials (decoration etc.).
- Always use and install the supplied safety cable as a safety measure to prevent accidental damage and/or injury in the event the clamp fails.



Important:

Overhead rigging requires extensive experience, including (but not limited to) calculating working load limits, specifying installation/ rigging materials, and periodic safety inspection of all installation material as well as the device. If you lack these qualifications, do not attempt the rigging of this device yourself. Improper installation/ rigging can result in serious bodily injury.

6. DMX-512 CONTROL CONNECTION

Connect the provided male side of the XLR cable to the female XLR output of your controller and the female side of the XLR cable to the male XLR input of the device. You can connect multiple devices together in a serial fashion. The cable needed should be two core, screened cable with XLR input and output connectors. Please refer to the diagram below.

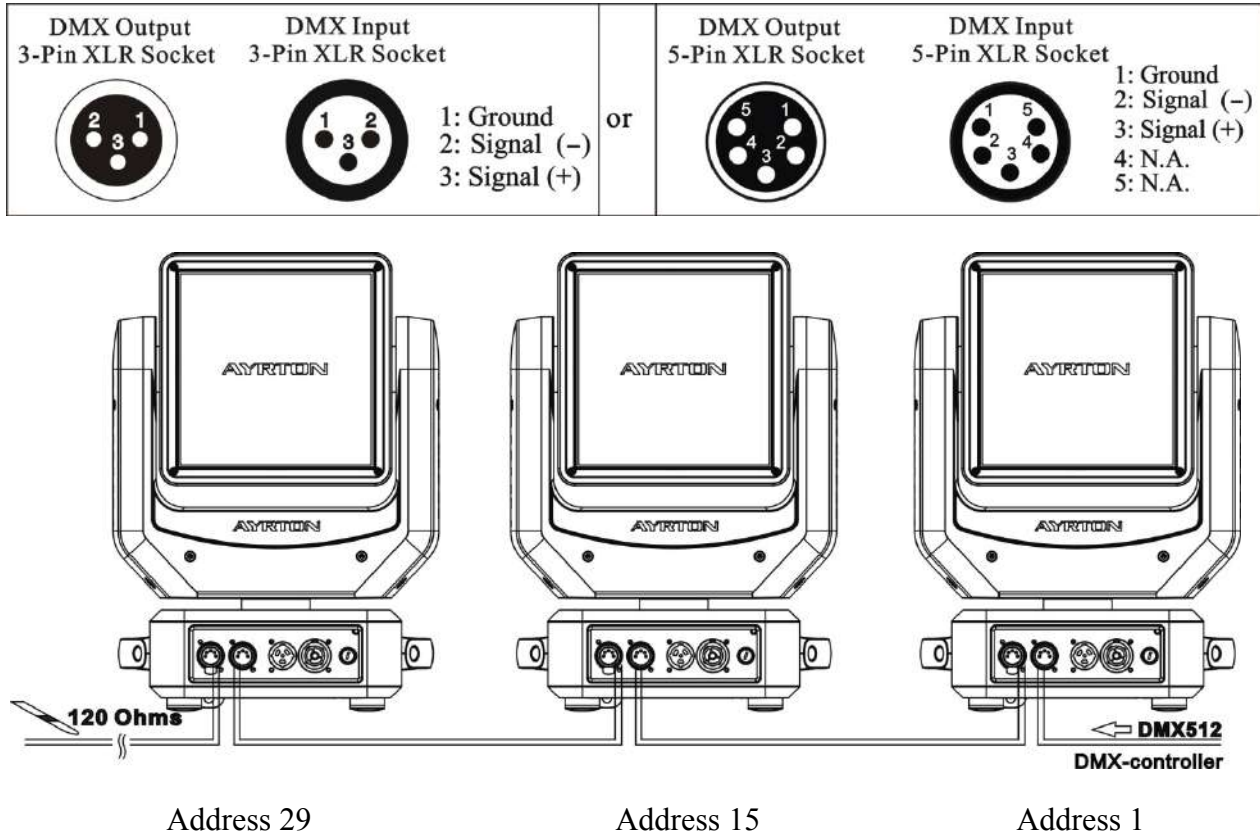

7. DMX-512 CONNECTION WITH DMX TERMINATOR

For installations where the DMX cable has to run over a long distance or is in an electrically noisy environment, such as in a discotheque, it is recommended to use a DMX terminator. This helps in preventing corruption of the digital control signal caused by electrical noise. The DMX terminator is an XLR plug with a 120 Ω resistor connected between pins 2 and 3, which is then plugged into the output (female) XLR socket of the last fixture in the chain. Please see illustrations below.



8. DEVICE DMX START ADDRESS SELECTION

All fixtures should be given a DMX starting address when using a DMX signal, so that the correct fixture responds to the correct control signals. This digital starting address is the channel number from which the fixture starts to “listen” to the digital control information sent out from the DMX controller. The allocation of this starting address is achieved by setting the correct address number on the display located on the base of the device.

You can set the same starting address for all fixtures or a group of fixtures, or set different addresses for each fixture individually.

If you set the same address on all devices, all the devices will start to “listen” to the same control signal from the same channel number. In other words, changing the settings of one channel will affect all the fixtures simultaneously.

If you set a different address, each unit will start to “listen” to the channel number you have set, based on the quantity of control channels of the unit. That means changing the settings of one channel will affect only the selected device.

In the case of the LED moving head, in 14channel mode, you should set the starting address of the first unit to 1, the second unit to 15 (14 + 1), the third unit to 29 (14+ 15), and so on.

9. OPERATING INSTRUCTIONS OF THE INTERNAL DMX WIRELESS SYSTEM

9.1 Equipments:

DMX 512 controller, wireless transmitter, and the fixtures with wireless receiver.

9.2 Message from the LED indicator:

- 1) Rapid flashing red/Green: logging in to a transmitter.
- 2) Slow flashing Red/Green: Logged on a transmitter and the DMX line is idle (No DMX is connected to transmitter) .
- 3) Solid Green: Logged on to a transmitter and receiving DMX data.
- 4) Solid Red: Not logged on to a transmitter (free) .

9.3 WDMX in the menu of the fixture:

On a fixture installed with wireless system, in order to switch between wireless control system and traditional DMX control (with cable) , a new menu WDMX is added to the display board.

ON: (Activate WDMX)

- 1) When the fixture is on power, and the WDMX is activated to ON status, but did not connect to the controller and did not log in to the transmitter, the fixture will search for the DMX signal source. If the fixture is connected to the DMX controller it can be controlled by DMX controller; if it is log in to the wireless transmitter, it can be controlled by the Transmitter.
- 2) When the fixture is power off, and the WDMX is in ON status, if the fixture is connected to DMX controller. After the fixture is power on, it can be controlled only by the DMX controller which connected. The fixture can log in the wireless transmitter, and receive only radio signal from transmitter, but not DMX from the transmitter.

OFF: (De-activate WDMX)

In this status, wireless system is not activated, so the fixture can not log in the transmitter.

REST: (reset WDMX memory)

Can remove the fixture from the connection with the transmitter, the fixture become free and ready to log in any transmitter.

9.4 Setup the wireless system:

- 1) Connect the transmitter with the DMX controller.
- 2) To make the fixture installed with wireless receiver log in to the transmitter.
 - a) Initially, the indicator on the receiver fixture should be in Solid red.
 - b) Press and hold the configuration button on transmitter for less than 3 seconds the red/green LEDs on the transmitter and the receiver fixture will flash rapidly for about 5~ 10 seconds while the system goes through its setup procedure.
 - c) Once the receiver fixture is logged in to the transmitter (T1) , the fixture with wireless receiver will keep the memory, even if restart the power, this unit will log in the transmitter (T1) automatically.
- 3) Use the DMX 512 to control the fixture

9.5 Remove the receivers from transmitter(T1)and to log in to another transmitter(T2):

Case 1: Remove a receiver:

- a) On the control board of the fixture, enter menu to activated the function of REST;
- b) The LED for wireless on the fixture should turn to Solid red; the receiver can log out from the transmitter (T1) ;
- c) press the configuration button on transmitter (T2) for less than 3 second, then the fixture will start to connect with the transmitter (T2) .

Case 2: Remove all receivers from a transmitter (T1) to log in to T2:

- a) Press and hold the configuration button on the T1 as least 5 seconds, can clear the connection with all the fixtures;
- b) All the red/green LEDs on the receiver fixtures will turn to Solid red to indicate that the receivers are unassigned and removed from the transmitter (T1) ;
- c) Press and hold the configuration button on the T2 less then less than 3 second, the fixtures will connect with the T2.













PS:



1. Please log the receivers out from the transmitter after every job, so that the receivers are in free un assigned state and ready to be assigned to a transmitter.
2. Do not connect the fixture which is under the communication of wireless system to the DMX controller, otherwise it will cause interference from the DMX controller.

10. DISPLAY

The Display offers several features: you can set the starting address, run the pre-programmed

program or reset the device.

The main menu is accessed by pressing the  -button until the display starts flashing. Browse through the menu by pressing the  -button,  -button,  -button or  -button. Press the Enter-button in order to select the desired menu. You can change the selection by pressing the  -button,  -button,  -button or  -button. Confirm every selection by pressing the  -button. You can leave every mode by pressing the  -button. After accessing the edit mode, the unit will automatically exit to the main menu after 15 seconds from the last button press. When the unit is powered on, if no data signal is connected after 1 minute, then the display will switch off automatically. The Display does not need external power to operate. Hold down the  -button for 10 seconds and the Display will turn on by using the unit's battery built in battery.

CAUTION!	
THE BATTERY MUST BE A LI-ION RECHARGEABLE BATTERY, THE SPECIFICATION IS AS FOLLOWING:	
	 Li-ion Rechargeable Battery ICR 14500 3.7V

Default settings shaded

Address	Address	xxx	DMX address setting
Users Mode	User Mode	Stand Mode Basic Mode Extend Mode Extend Mode 2 User Mode A User Mode B User Mode C	User's mode to change channel numbers
	Edit User	Max channel PAN :	Preset User modes A,B,C
Options	Status	Pan Reverse ON/OFF Tilt Reverse ON/OFF Pan Degree 630/540 Tilt Degree 270/540 Feedback ON/OFF Pan/Tilt Spd Speed 1~ 4 Hibernation OFF, 01M~99M, OFF	Pan Reverse movement Tilt Reverse movement Pan Degree Select Tilt Degree Select Movement Feedback Movement Speed Stand by Mode

	Service PIN	Service PIN RDM UID Set LED BIN Change To BIN	Password=XXX XXXXXX XXXXXX XXXXXX	Service Password =“050” RDM UID Set LED BIN Change To BIN
	Fans Control	Head Control	Auto Stage Studio	Fans Speed select
	Disp.Setting	Shutoff Time Flip Display Key Lock DispFlash	02~60m 05m ON/OFF ON/OFF ON/OFF	Display shutoff time Reverse 180 degree Key Lock DispFlash
	Signal Select	DMX WDMX		DMX WDMX
	Temp. C/F	Celsius Fahrenheit		Temperature switch between □/□
	Initial Pos.	PAN =XXX		Initial effect position
	Wireless DMX	Activate WDMX Act&Data Out Rest WDMX		Activate WDMX Act&Data Out Rest WDMX
	Trigger	DMX Value Disp. Auto Program	PAN.....	DMX Value Disp. Auto Program
	ResetDefault	ON/OFF		Restore factory set.
Info	Time Info.	Current Time Ttl Life Hrs Last Run Hrs Timer PIN Clr Last Run		XXXX(Hours) XXXX(Hours) XXXX(Hours) Password=XXX ON/OFF
	Temp. Info	Head Temp.		Temperature in the head
	Software Ver	V1.0.....		Software version
Test	Home	All Pan&Tilt		Reset All Reset Pan&Tilt
	Test Channel	PAN		Test function
	Manual Ctrl.	PAN =XXX :		Fine adjustment of the lamp
	Calibration	-Password- PAN :		Password “050” Calbrate and adjust the effects to standard/right position
Preset	Select Prog.	Prog. Part 1 = Program 1 ~ 10 Program 1 Prog. Part 2 = Program 1 ~ 10 Program 2 Prog. Part 3 = Program 1 ~ 10 Program 3	Select programs to be run	

	Edit Prog.	Program 1 : Program 10	Program Test Step 01=SCxxx Step 64=SCxxx	Testing program Program in loop Save and exit
	Edit Scenes	Edit Scene 001 ~ Edit Scene 250	Pan,Tilt,..... --Fade Time-- --Secne Time-- Input By Outside	Save and automatically return manual scenes edit
	Scenes Input	XX~XX		Scenes Input

10.1. FUNCTION

10.1.1. Set DMX Address

With this function, you can adjust the desired DMX-address via the Display.

1. Access the main menu.
2. Tap the <Up/Down> button until “Set DMX Address” is displayed.
3. Press ENTER, the display will show “Set DMX Address” .
4. Tap the <Up/Down> button, the display will show “XXX” .
5. Press ENTER to confirm or press <MODE/ESC> to return to the main menu.

10.2. USERS MODE

10.2.1. User Mode

With this function, you can create user defined channel orders.

1. Tap <MODE/ESC> button, access the main menu, Tap the <Up/Down> button until “Users mode” is displayed.Press <ENTER>, the display will show “Users mode” .
2. Press <Up/Down>, the display will show “User Mode” .
3. Press< ENTER>, the display will show “User Mode” .
4. The display show “Standard Mode”, Press <Up/Down> button, then you can choose “Basic Mode”, “Extended Mode”, “Extended Mode 2”, “User Mode A”, “User Mode B”, “User Mode C” .
5. Press <ENTER> to confirm or press <MODE/ESC> to return to the main menu.

10.2.2. Edit User

With this function, you can adjust the rest user defined channel order.

1. Tap <MODE/ESC> button, access the main menu, Tap the <Up/Down> button until “Users mode” is displayed.Press <ENTER>, the display will show “Users mode” .
2. Press <Up/Down>, the display will show “Edit User” .
3. Press< ENTER>, the display will show “Edit User” .
4. The display show “Max Channel”, Press <Up/Down> button, then you can choose “PAN” .
5. Press <ENTER> to confirm or press <MODE/ESC> to return to the main menu.

10.3. OPTIONS

10.3.1. Status

Pan Reverse

With this function you can reverse the Pan-movement.

1. Tap <MODE/ESC> button, access the main menu, Tap the <Up/Down> button until “Options” is displayed.Press ENTER, the display will show “Options” .Tap the <Up/Down> button until the display will show “Status” .Press ENTER, the display will show “Status” .
2. Press <Up/Down>, the display will show “Pan Reverse” .
3. Press< ENTER>, the display will show “Pan Reverse” .
4. The display show “OFF”, Press <Up/Down>, the display will show “ON” .
5. Press <ENTER> to confirm or press <MODE/ESC> to return to the main menu.

Tilt Reverse

With this function you can reverse the Tilt-movement.

1. Tap <MODE/ESC> button, access the main menu, Tap the <Up/Down> button until “Options” is displayed.Press ENTER, the display will show “Options” .Tap the <Up/Down> button until the display will show “Status” .Press ENTER, the display will show “Status” .
2. Press <Up/Down>, the display will show “Tilt Reverse” .
3. Press< ENTER>, the display will show “Tilt Reverse” .
4. The display show “OFF”, Press <Up/Down>, the display will show “ON” .
5. Press <ENTER> to confirm or press <MODE/ESC> to return to the main menu.

Pan Degree

With this function, you can select pan degree for 630 or 540.

1. Tap <MODE/ESC> button, access the main menu, Tap the <Up/Down> button until “Options” is displayed.Press ENTER, the display will show “Options” .Tap the <Up/Down> button until the display will show “Status” .Press ENTER, the display will show “Status” .
2. Press <Up/Down>, the display will show “Pan Degree” .
3. Press< ENTER>, the display will show “Pan Degree” .
4. The display show “540”, Press <Up/Down>, the display will show “630” .
5. Press <ENTER> to confirm or press <MODE/ESC> to return to the main menu.

Tilt Degree

With this function, you can select tilt degree for 270 or 540.

1. Tap <MODE/ESC> button, access the main menu, Tap the <Up/Down> button until “Options” is displayed.Press ENTER, the display will show “Options” .Tap the <Up/Down> button until the display will show “Status” .Press ENTER, the display will show “Status” .
2. Press <Up/Down>, the display will show “Tilt Degree” .
3. Press< ENTER>, the display will show “Tilt Degree” .
4. The display show “540”, Press <Up/Down>, the display will show “270” .
5. Press <ENTER> to confirm or press <MODE/ESC> to return to the main menu.

Feedback

With this function, you can feedback switch of pan movement or tilt movement.

1. Tap <MODE/ESC> button, access the main menu, Tap the <Up/Down> button until

“Options” is displayed. Press ENTER, the display will show “Options”. Tap the <Up/Down> button until the display will show “Status”. Press ENTER, the display will show “Status” .

2. Press <Up/Down>, the display will show “Feedback” .
3. Press <ENTER>, the display will show “Feedback” .
4. The display show “ON”, Press <Up/Down>, the display will show “OFF” .
5. Press <ENTER> to confirm or press <MODE/ESC> to return to the main menu.

Pan/Tilt Spd

With this function, you can select the pan/tilt speed.

1. Tap <MODE/ESC> button, access the main menu, Tap the <Up/Down> button until “Options” is displayed. Press ENTER, the display will show “Options”. Tap the <Up/Down> button until the display will show “Status”. Press ENTER, the display will show “Status” .
2. Press <Up/Down>, the display will show “Pan/Tilt Spd” .
3. Press <ENTER>, the display will show “Pan/Tilt Spd” .
4. The display show “Speed 1”, Press <Up/Down>, the display will show “Speed 1”, “Speed 2”, “Speed 3”, “Speed 4” .
5. Press <ENTER> to confirm or press <MODE/ESC> to return to the main menu.

Hibernation: Standby mode

The device and step motors will be power off if the fixture stay without DMX signal for 15 mins (Factory default). And the fixture will be reset before working once it receive DMX signal again.

1. Tap <MODE/ESC> button, access the main menu, Tap the <Up/Down> button until “Options” is displayed. Press ENTER, the display will show “Options”. Tap the <Up/Down> button until the display will show “Status”. Press ENTER, the display will show “Status” .
2. Press <Up/Down>, the display will show “Hibernation” .
3. Press <ENTER>, the display will show “Hibernation” .
4. The display show “15M”, Press <Up/Down>, the display will show “01M”, “02M” . . . “99M” or “OFF” .
5. Press <ENTER> to confirm or press <MODE/ESC> to return to the main menu.

10.3.2. Service PIN

Service PIN

The Password for this function is “050” .

RDM UID

With this function you can call up various submenus via RDM.

This device is RDM ready. RDM stands for “remote device management” and makes remote control of devices connected to the DMX-bus possible. ANSI E1.20-2006 by ESTA specifies the RDM standard as an extension of the DMX512 protocol.

1. Tap <MODE/ESC> button, access the main menu, Tap the <Up/Down> button until “Options” is displayed. Press ENTER, the display will show “Options”. Tap the <Up/Down> button until the display will show “Service PIN”. Press ENTER, the display will show “Service PIN” .
2. Press <Up/Down>, the display will show “RDM UID” .

3. Press< ENTER>, the display will show “RDM UID” .
4. The display show “XXXXXX” .
5. Press <ENTER> to confirm or press <MODE/ESC> to return to the main menu.

Set LED BIN

1. Tap <MODE/ESC> button, access the main menu, Tap the <Up/Down> button until “Options” is displayed.Press ENTER, the display will show “Options” .Tap the <Up/Down> button until the display will show“Service PIN”.Press ENTER, the display will show “Service PIN” .
2. Press <Up/Down>, the display will show “Set LED BIN” .
3. Press< ENTER>, the display will show “Set LED BIN” .
4. The display show “XXXXXX” .
5. Press <ENTER> to confirm or press <MODE/ESC> to return to the main menu.

Change To BIN

1. Tap <MODE/ESC> button, access the main menu, Tap the <Up/Down> button until “Options” is displayed.Press ENTER, the display will show “Options” .Tap the <Up/Down> button until the display will show“Service PIN”.Press ENTER, the display will show “Service PIN” .
2. Press <Up/Down>, the display will show “Change To BIN” .
3. Press< ENTER>, the display will show “Change To BIN” .
4. The display show “XXXXXX” .
5. Press <ENTER> to confirm or press <MODE/ESC> to return to the main menu.

10.3.3. Fans Control

1. Tap <MODE/ESC> button, access the main menu, Tap the <Up/Down> button until “Options” is displayed.Press ENTER, the display will show “Options” .Tap the <Up/Down> button until the display will show “Fans Control” .Press ENTER, the display will show “Fans Control” .
2. Press <Up/Down>, the display will show “Head Control” .
3. Press< ENTER>, the display will show “Head Control” .
4. The display show“Auto”, Press <Up/Down>, the display will show“Stage”, “Studio” .
5. Press <ENTER> to confirm or press <MODE/ESC> to return to the main menu.

10.3.4. Disp.Setting

Shut off Time

With this function you can shut off the LCD display after 2 to 60 minutes.The default is 5 minutes.

1. Tap <MODE/ESC> button, access the main menu, Tap the <Up/Down> button until “Options” is displayed.Press ENTER, the display will show “Options” .Tap the <Up/Down> button until the display will show “Disp.Setting” .Press ENTER, the display will show “Disp.Setting” .
2. Press <Up/Down>, the display will show “Shut off Time” .
3. Press< ENTER>, the display will show “Shut off Time” .
4. The display show “05m”, Press <Up/Down>, the display will show “02~60m” .
5. Press <ENTER> to confirm or press <MODE/ESC> to return to the main menu.

Flip Display

With this function you can rotate the display by 180°.

1. Tap <MODE/ESC> button, access the main menu, Tap the <Up/Down> button until “Options” is displayed.Press ENTER, the display will show “Options” .Tap the <Up/Down> button until the display will show “Disp.Setting” .Press ENTER, the display will show “Disp.Setting” .
2. Press <Up/Down>, the display will show “Flip Display” .
3. Press< ENTER>, the display will show “Flip Display” .
4. The display show “OFF”, Press <Up/Down>, the display will show “ON” .
5. Press <ENTER> to confirm or press <MODE/ESC> to return to the main menu.

Key Lock

With this function you can activate the automatic key lock function.If this function is activated, the keys will be locked automatically after exiting the edit mode for 15 seconds.keeping press the <MODE/ESC> key for 3seconds if you do not need this function.

1. Tap <MODE/ESC> button, access the main menu, Tap the <Up/Down> button until “Options” is displayed.Press ENTER, the display will show “Options” .Tap the <Up/Down> button until the display will show “Disp.Setting” .Press ENTER, the display will show “Disp.Setting” .
2. Press <Up/Down>, the display will show “Key Lock” .
3. Press< ENTER>, the display will show “Key Lock” .
4. The display show “OFF”, Press <Up/Down>, the display will show “ON” .
5. Press <ENTER> to confirm or press <MODE/ESC> to return to the main menu.

DispFlash

With this function you can display when no DMX.

1. Tap <MODE/ESC> button, access the main menu, Tap the <Up/Down> button until “Options” is displayed.Press ENTER, the display will show “Options” .Tap the <Up/Down> button until the display will show “Disp.Setting” .Press ENTER, the display will show “Disp.Setting” .
2. Press <Up/Down>, the display will show “DispFlash” .
3. Press< ENTER>, the display will show “DispFlash” .
4. The display show “OFF”, Press <Up/Down>, the display will show “ON” .
5. Press <ENTER> to confirm or press <MODE/ESC> to return to the main menu.

10.3.5. Signal Select

1. Tap <MODE/ESC> button, access the main menu, Tap the <Up/Down> button until “Options” is displayed.Press ENTER, the display will show “Options” .
2. Press <Up/Down>, the display will show “Signal Select” .
3. Press< ENTER>, the display will show “Signal Select” .
4. The display shows “DMX” , Press <Up/Down>, the display will show “WDMX” .
5. Press <ENTER> to confirm or press <MODE/ESC> to return to the main menu.

10.3.6. Temp. C/F

With this function you can display the temperature in Celsius or Fahrenheit.

1. Tap <MODE/ESC> button, access the main menu, Tap the <Up/Down> button until “Options” is displayed.Press ENTER, the display will show “Options” .
2. Press <Up/Down>, the display will show “Temp. C/F” .

3. Press< ENTER>, the display will show “Temp. C/F” .
4. The display show “Celsius”, Press <Up/Down>, the display will show “Fahrenheit” .
5. Press <ENTER> to confirm or press <MODE/ESC> to return to the main menu.

10.3.7. Initial Pos.

With this function you can display initial effect position.

1. Tap <MODE/ESC> button, access the main menu, Tap the <Up/Down> button until “Options” is displayed.Press ENTER, the display will show “Options” .
2. Press <Up/Down>, the display will show “Initial Pos.” .
3. Press< ENTER>, the display will show “Initial Pos.” .
4. The display show “PAN=XXX” .
5. Press <ENTER> to confirm or press <MODE/ESC> to return to the main menu.

10.3.8. Wireless DMX

With this function you can display the wireless DMX.

1. Tap <MODE/ESC> button, access the main menu, Tap the <Up/Down> button until “Options” is displayed.Press ENTER, the display will show “Options” .
2. Press <Up/Down>, the display will show “Wireless DMX” .
3. Press< ENTER>, the display will show “Wireless DMX” .
4. The display show “Activate WDMX”, Press <Up/Down>, the display will show “Act&Data Out”, “Rest WDMX” .
5. Press <ENTER> to confirm or press <MODE/ESC> to return to the main menu.

10.3.9. Trigger

DMX Value Disp.

With this function you can display the DMX 512 value of each channel.The display automatically shows the channel with a changing value.

1. Tap <MODE/ESC> button, access the main menu, Tap the <Up/Down> button until “Options” is displayed.Press ENTER, the display will show “Options” .Tap the <Up/Down> button until the display will show“Trigger”.Press ENTER, the display will show “Trigger” .
2. Press <Up/Down>, the display will show “DMX Value Disp.” .
3. Press< ENTER>, the display will show “DMX Value Disp.” .
4. Tap the <Up/Down> button, choose each channel..
5. Press <ENTER> to confirm or press <MODE/ESC> to return to the main menu.

Auto Program

With this function, you can run the internal program.You can select the desired program under “**Select program**” .You can set the number of steps under “**Edit program**” .You can edit the individual scenes under“**Edit scenes**”.With this function, you can run the individual scenes either automatically, i.e.with the adjusted Step-Time.

1. Tap <MODE/ESC> button, access the main menu, Tap the <Up/Down> button until “Options” is displayed.Press ENTER, the display will show “Options” .Tap the <Up/Down> button until the display will show“Trigger”.Press ENTER, the display will show “Trigger” .
2. Press <Up/Down>, the display will show “Auto Program” .
3. Press< ENTER>, the display will show “Auto Program” .
4. Tap the <Up/Down> button, choose the channel.

5. Press <ENTER> to confirm or press <MODE/ESC> to return to the main menu.

10.3.10. ResetDefault

With this function, you can select restore factory set for ON or OFF, the default is OFF.

1. Tap <MODE/ESC> button, access the main menu, Tap the <Up/Down> button until “Options” is displayed. Press ENTER, the display will show “Options” .
2. Press <Up/Down>, the display will show “ResetDefault” .
3. Press< ENTER>, the display will show “ResetDefault” .
4. The display show “OFF”, Press <Up/Down>, the display will show “ON” .
5. Press <ENTER> to confirm or press <MODE/ESC> to return to the main menu.

10.4. INFO

10.4.1. Time Info.

Current Time

With this function, you can display the temporary running time of the device from the last power on. The display shows “XXXX”, “XXXX” stands for the number of hours. The counter is reset after turning the device off.

1. Tap <MODE/ESC> button, access the main menu, Tap the <Up/Down> button until “Info” is displayed. Press ENTER, the display will show “Info” . Tap the <Up/Down> button until the display will show “Time Info” . Press ENTER, the display will show “Time Info” .
2. Press <Up/Down>, the display will show “Current Time” .
3. Press< ENTER>, the display will show “Current Time” .
4. The display will show “XXXX” (Hours).
5. Press <ENTER> to confirm or press <MODE/ESC> to return to the main menu.

Ttl Life Hrs

With this function, you can display the running time of the device. The display shows “XXXX” , “XXXX” stands for the number of hours.

1. Tap <MODE/ESC> button, access the main menu, Tap the <Up/Down> button until “Info” is displayed. Press ENTER, the display will show “Info” . Tap the <Up/Down> button until the display will show “Time Info” . Press ENTER, the display will show “Time Info” .
2. Press <Up/Down>, the display will show “Ttl Life Hrs” .
3. Press< ENTER>, the display will show “Ttl Life Hrs” .
4. The display will show “XXXX” (Hours).
5. Press <ENTER> to confirm or press <MODE/ESC> to return to the main menu.

Last Run Hrs

With this function, you can display last the running time of the device. The display shows “XXXX” , “XXXX” stands for the number of hours.

1. Tap <MODE/ESC> button, access the main menu, Tap the <Up/Down> button until “Info” is displayed. Press ENTER, the display will show “Info” . Tap the <Up/Down> button until the display will show “Time Info” . Press ENTER, the display will show “Time Info” .

2. Press <Up/Down>, the display will show “Last Run Hrs” .
3. Press< ENTER>, the display will show “Last Run Hrs” .
4. The display will show “XXXX” (Hours) .
5. Press <ENTER> to confirm or press <MODE/ESC> to return to the main menu.

Timer PIN

With this function, you can display the timer password.

1. Tap <MODE/ESC> button, access the main menu, Tap the <Up/Down> button until “Info” is displayed. Press ENTER, the display will show “Info” .Tap the <Up/Down> button until the display will show “Time Info” .Press ENTER, the display will show “Time Info” .
2. Press <Up/Down>, the display will show “Timer PIN” .
3. Press< ENTER>, the display will show “Timer PIN” .The time password is 038.
4. Press <ENTER> to confirm or press <MODE/ESC> to return to the main menu.

Clr Last Run

With this function, you can clear last run time of the fixture.The display shows “ON” or “OFF”, Press “Enter” to confirm.

1. Tap <MODE/ESC> button, access the main menu, Tap the <Up/Down> button until “Info” is displayed. Press ENTER, the display will show “Info” .Tap the <Up/Down> button until the display will show “Time Info” .Press ENTER, the display will show “Time Info” .
2. Press <Up/Down>, the display will show “Clr Last Run” .
3. At “L-Timer Password” menu input right password, Press< ENTER>, the display will show “Clr Last Run” .
4. The display show “OFF”, Press <Up/Down>, the display will show “ON” .
5. Press <ENTER> to confirm or press <MODE/ESC> to return to the main menu.

10.4.2. Temp. Info

Head Temp.

With this function you can display the temperature on the display board of the base (near CMY-filter) in Celsius.

1. Tap <MODE/ESC> button, access the main menu, Tap the <Up/Down> button until “Info” is displayed. Press ENTER, the display will show “Info” .Tap the <Up/Down> button until the display will show “Temp. Info” .Press ENTER, the display will show “Temp. Info” .
2. Press <Up/Down>, the display will show “Head Temp.” .
3. Press< ENTER>, the display will show “Head Temp.” .
4. The display show “XXX °C/ °F” .
5. Press <ENTER> to confirm or press <MODE/ESC> to return to the main menu.

10.4.3. Software Ver

With this function, you can display the software version of the device.

1. Tap <MODE/ESC> button, access the main menu, Tap the <Up/Down> button until “Info” is displayed.Press ENTER, the display will show “Info” .
2. Press <Up/Down>, the display will show “Software Ver” .
3. Press< ENTER>, the display will show “Software Ver” .
4. The display show “Ver x.x.x” .

5. Press <ENTER> to confirm or press <MODE/ESC> to return to the main menu.

10.5.TEST

10.5.1. Home

With this function you can reset the device via the Display.You can select the different reset functions from the display screen or a DMX console.

1. Tap <MODE/ESC> button, access the main menu, Tap the <Up/Down> button until “Test” is displayed.Press ENTER, the display will show “Test” .
2. Press <Up/Down>, the display will show “Home” .
3. Press< ENTER>, the display will show “Home” .
4. The display show “All”, Press <Up/Down>, the display will show “Pan&Tilt” .
5. Press <ENTER> to confirm or press <MODE/ESC> to return to the main menu.

10.5.2. Test Channel

With this function you can test each channel’s function to ensure correct operation.

1. Tap <MODE/ESC> button, access the main menu, Tap the <Up/Down> button until “Test” is displayed.Press ENTER, the display will show “Test” .
2. Press <Up/Down>, the display will show “Test Channel” .
3. Press< ENTER>, the display will show “Test Channel” .
4. The display shows “Pan” first channel, Press <Up/Down>, can choose other channel.
5. Press <ENTER> to confirm or press <MODE/ESC> to return to the main menu.

10.5.3. Manual Control

When set to Manual Mode, fixture will be back to factory settings.If want to adjust brightness, can adjust by shutter and dimming channel, channel value is 0-255.Other functions can be set according to user's real need.

1. Tap <MODE/ESC> button, access the main menu, Tap the <Up/Down> button until “Test” is displayed.Press ENTER, the display will show “Test” .
2. Press <Up/Down>, the display will show “Manual Control” .
3. Press< ENTER>, the display will show “Manual Control” .
4. The display show “PAN=XXX” .
5. Press <ENTER> to confirm or press <MODE/ESC> to return to the main menu.

10.5.4. Calibration

With this function, you can calibrate and adjust the effect wheels to their correct positions.The password of calibrate values is 050.

1. Tap <MODE/ESC> button, access the main menu, Tap the <Up/Down> button until “Test” is displayed.Press ENTER, the display will show “Test” .
2. Press <Up/Down>, the display will show “Calibration” .
3. Press< ENTER>, the display will show “Calibration” .
4. The display show “Pan=XXX” .
5. Press <ENTER> to confirm or press <MODE/ESC> to return to the main menu.

10.6.PRESET

1. Tap <MODE/ESC> button, access the main menu.

2. Tap <Up/Down> until “Preset” is displayed.
3. Press<ENTER>, the display will show “Preset” .
4. The display show“Select Prog.”, Press <Up/Down>, the display will show“Edit Prog.”, “Edit Scenes”, “Scenes Input” .
5. Press <ENTER> to confirm or press <MODE/ESC> to return to the main menu.

Run the auto program: A master fixture can output to three different program signals to the slave fixture to operate.It means the host will send cyclically in the following orders (The host will keep operating the program of Part 1) Then the slave fixture will make the selectively receiving according to its own set.

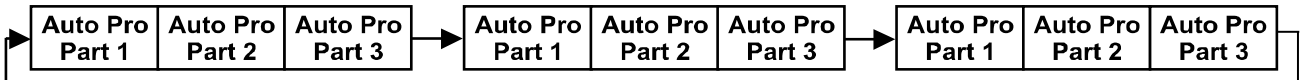

1. If the slave fixture chooses Run For Slave 1 from the menu of 1-3,then it will receive the part 1’s automatic program from link, in the same way, when the slave fixture chooses Run For Slave 2, then it will receive the part 2’s automatic program from link.
2. Enter the menu of 1-3 Function Mode---Set To Slave, Here to set machine operate which part of the program during the host-slave connection
3. Enter the menu of 1-4, 1-5 Function Mode---Set To Master
4. Enter the menu of 8-1 Edit Program---Auto Program Part1.The host outputs three groups driven program---Part1, Part2, Part3(Part1 program runs the same effect as the host)
5. Enter the menu of 8-2 Edit Program---Edit Program.Edit the program’s connection, connect the scene in order
6. The editor of the scene, there are as many as 250 scenario editors, and every scene can have a program connection of 10.

Note:

Part 2, Part 3 repeat in accordance with the Part1’s repeat.For example: When Part 1 uses Program 2, Part 2 uses Program 4, Part 3 uses Program 6, Assume: Program 2 includes scene of 10, 11, 12, 13; Program 4 includes scene of 8, 9, 10; Program 6 includes scene of 12, 13, 14, 15; Then it will run as below.

Example:

Part 1:

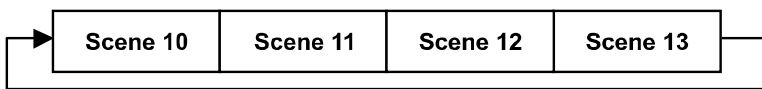

Part 2:

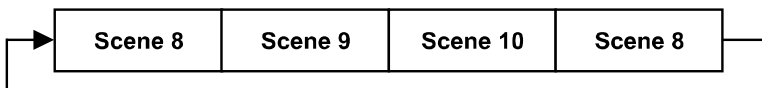

Part 3:

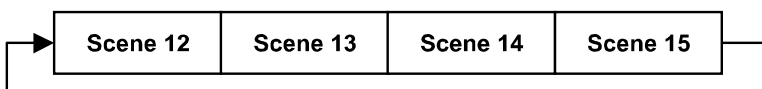

11. DMX PROTOCOL

DMX channel's functions and their values (59 DMX channels):					
Mode/Channel			Value	Function	
St	Ba	Ex	Ex 2		
A1	A1	A1	A1	PAN Movement 8bit :	
				0-255	Pan Movement
A2		A2	A2	Pan Fine 16bit	
				0-255	Fine control of Pan movement
A3	A2	A3	A3	TILT Movement 8bit :	
				0-255	Tilt Movement
A4		A4	A4	Tilt Fine 16bit	
				0-255	Fine control of Tilt movement
A5	A3	A5	A5	Speed Pan/Tilt movement:	
				0-225	max to min speed
				226-235	blackout by movement
				236-255	no function
A6	A4	A6	A6	Pan Motor continuous rotation	
				0-127	no function
				128-189	Forwards Pan rotation from fast to slow
				190-193	No rotation
				194-255	Backwards Pan rotation from slow to fast
A7	A5	A7	A7	Tilt Motor continuous rotation	
				0-127	no function
				128-189	Forwards Tilt rotation from fast to slow
				190-193	No rotation
				194-255	Backwards Tilt rotation from slow to fast
A8	A6			Dimmer intensity:	
				0-255	Intensity 0 to 100%
A9	A7		A8	Duration:	
				0-255	duration from 2msec to 600msec
A10	A8		A9	Rate:	
				0-5	led off
				6-255	from 1 flash evry 4 sec to 25 flash evry sec
A11	A9	A8	A10	Chase Patterns:	
				0--9	Led trun off
				10	Chase 1
				14	Chase 2
				18	Chase 3
				22	Chase 4
				26	Chase 5

			30	Chase 6
			34	Chase 7
			38	Chase 8
			42	Chase 9
			46	Chase 10
			50	Chase 11
			54	Chase 12
			58	Chase 13
			62	Chase 14
			66	Chase 15
			70	Chase 16
			74	Chase 17
			78	Chase 18
			82	Chase 19
			86	Chase 20
			90	Chase 21
			94	Chase 22
			98	Chase 23
			102	Chase 24
			106	Chase 25
			110	Chase 26
			114	Chase 27
			118	Chase 28
			122	Chase 29
			126	Chase 30
			130	Chase 31
			134	Chase 32
			138	Chase 33
			142	Chase 34
			146	Chase 35
			150	Chase 36
			154	Chase 37
			158	Chase 38
			162	Chase 39
			166	Chase 40
			170	Chase 41
			174	Chase 42
			178	Chase 43
			182	Chase 44
			186	Chase 45
			190	Chase 46
			194	Chase 47
			198	Chase 48
			202	Chase 49
			206	Chase 50
			210	Chase 51

				214	Chase 52
				218	Chase 53
				222	Chase 54
				226	Chase 55
				230	Chase 56
				234	Chase 57
				238-255	Reserved
A12	A10	A9	A11		Chase Speed:
				0-125	Fast to Slow Backward
				126-130	Stop(Speed=0)
				131-255	Slow to Fast Forward
A13	A11	A10	A12		Chase Fade:
				0-255	Fade Chase
		A12	A14		Dimmer intensity Section 1:
				0-255	Intensity 0 to 100%
		A13			Duration Section 1:
				0-255	duration from 2msec to 600msec
		A14			Rate Section 1:
				0-5	led off
				6-255	from 1 flash evry 4 sec to 25 flash evry sec
				o o o o o o	---
		A57	A29		Dimmer intensity section 64:
				0-255	Intensity 0 to 100%
		A58			Duration section 64:
				0-255	duration from 2msec to 600msec
		A59			Rate section 64:
				0-5	led off
				6-255	from 1 flash evry 4 sec to 25 flash evry sec
A14	A12	A11	A13		Reset, internal programs:
				0-79	Normal
				80-84	All motor reset
				85-87	Scan motor reset
				88-90	no function
				91-93	no function
				94-96	no function
				97-99	no function
				100-119	Internal program 1 (secne1~8 of EEPROM)
				120-139	Internal program 2 (secne9~16 of EEPROM)
				140-159	Internal program 3 (secne17~24 of EEPROM)
				160-179	Internal program 4 (secne25~32 of EEPROM)
				180-199	Internal program 5 (secne33~40 of EEPROM)
				200-219	Internal program 6 (secne41~48 of EEPROM)
				220-239	Internal program 7 (secne49~56 of EEPROM)

				240-255	Internal program 8 (secne57~64 of EEPROM)
--	--	--	--	---------	---

12. ERROR MESSAGES

When you turn on the device, it will first perform a reset. The display may show “Err channel is XX” should there be problems with one or more functions. “XX” stands for channel 1, 2, 3, 4, 5, 6 etc whose sensor has encountered a problem. For example, when the display shows “Err channel is Pan movement”, it means there is an error on channel 1. If there are errors on channel 1, channel 2 at the same time, you may see the error message, “Err channel is Pan movement”, “Err channel is Tilt movement”, flash twice, and then the device will generate a second reset. If the error messages persist after performing a reset more than twice, the channels which have errors may not work properly however, all other functions can work as usual. Please contact your dealer or manufacturer for service. Self repair is not allowed.

PAN- movement Er

(PAN- yoke movement error) This message will appear after the reset of the fixture if the yoke’s magnetic-indexing circuit malfunction (Optical Sensor or Magnetic Sensor fails) or the stepper motor is defective (or its driving IC on the main PCB). The PAN- movement is not located in the default position after the reset.

TILT- movement Er

(TILT- head movement error) This message will appear after the reset of the fixture if the head’s magnetic-indexing circuit malfunctions ((Optical Sensor or Magnetic Sensor fails)) or the stepper motor is defective (or its driving IC on the main PCB). The TILT- movement is not located in the default position after the reset.

13. CLEANING AND MAINTENANCE

The following points have to be considered during inspection:

- 1) All screws for installing the devices or parts of the device have to be tightly connected and must not be corroded.
- 2) There must not be any deformations to the housing, lenses, rigging and installation points (ceiling, suspension, trussing).
- 3) Motorized parts must not show any signs of wear and must move smoothly without issue.
- 4) The power supply cables must not show any damage, material fatigue or sediment.

Further instructions depending on the installation location and usage have to be adhered to by a qualified installer and any safety concerns have to be removed.



CAUTION!

Disconnect from mains before starting maintenance operation.

In order to ensure the device remains in good condition and does not fail prematurely, we suggest regular maintenance.

- 1) Clean the inside and outside lens each week to avoid loss of output due to accumulation of dust/ dirt on the lens.
- 2) Clean the fans each week to ensure maximum airflow and efficient thermal cooling. This will ensure the light source is operated in the best possible condition.

- 3) A detailed electrical check by an approved electrician every quarter to make sure that the circuit contacts are in good condition. This will prevent poor circuit contacts and the resultant overheating.

We recommend frequent cleaning of the device. Please use a moist, lint-free cloth. Never use alcohol or solvents.

Please refer to the instructions under “Installation instructions” .

Should you need any spare parts, please order genuine parts from your local dealer.

Remark: Errors and omissions for all information given in this manual are excepted. All information is subject to change without prior notice.